

Datasheet

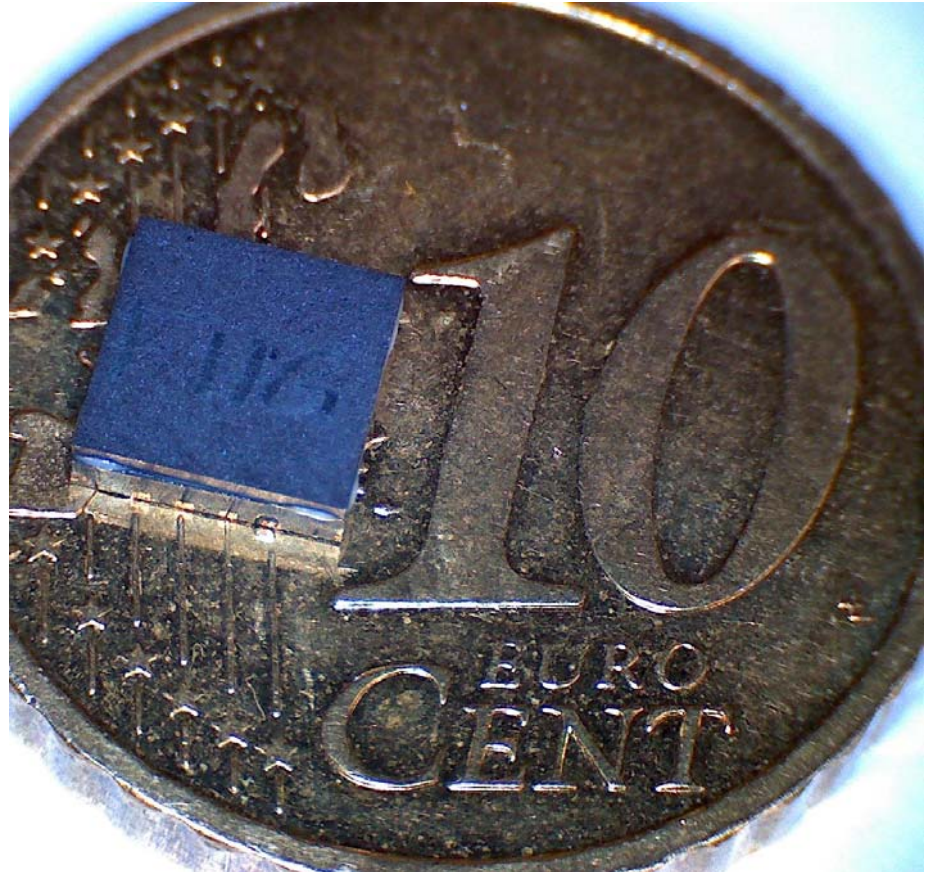

Fig 1: Micro power ASIC in 5 x 5 mm QFN-Package

Fraunhofer Institute for Integrated Circuits IIS

Director
Prof. Dr.-Ing. Albert Heuberger
Am Wolfsmantel 33
91058 Erlangen

Contact

Dr. Peter Spies
Phone +49 911 58061-6363
Fax +49 911 58061-6398
peter.spies@iis.fraunhofer.de

Nordostpark 93
90411 Nuremberg
Germany

www.smart-power.fraunhofer.de

Micro Energy Power Management ASIC 2 (ME-PMA2)

Description

The ME-PMA2 is a power management ASIC (Application Specific Integrated Circuit) to be used with energy sources of small output voltages like thermogenerators, solar cells or fuel cells.

Its special system architecture allows to be powered with energy sources below 500 mV with efficiencies up to 90 %.

The ASIC starts operating at 20 mV input voltage and produces output voltages from 1.5 up to 5 V to directly supply applications like sensors, transceivers or displays.

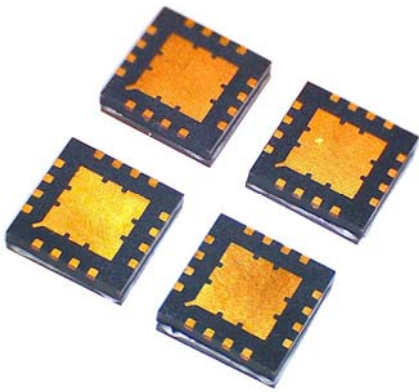

Fig. 2: Micro power ASIC in 5 x 5 mm QFN-Package

Features

- More than 75% Efficiency at 0.2 V Input Voltage and 3.7 V Output Voltage (at 0.8 mA Output Current)
- 20 mV Start-up Voltage (at a transformer winding ratio of 3:1)
- 300 ms Start-up Time at 0.2 V Input and 3.8 V Output Voltage

Applications

- Fuel Cells, Solar Cells, Thermoelectric Generators, Inductive Powered Products
- Transceivers (e.g. EnOcean STM100, TI CC2500)
- Wireless Sensors and Sensor Networks
- Battery Charger for Energy Harvesting Power Supplies

Electrical Characteristics

Parameter	Symbol	Conditions	Min	Typ	Max	Unit
Start-up input voltage	V_{in}	$R_{Load} = oc^*$	0.02		0.04	V
		$R_{Load} = 10\text{ k}\Omega$		0.038	0.04	V
Start-up time	t_{start}	$V_{in} = 0.2\text{ V}$ $V_{out} = 3.8\text{ V}$		300		ms
Output voltage range ($R_{Load} = 10\text{ k}\Omega$)	V_{out}	$V_{in} = 0.05\text{ V}$	0.0		1.9	V
		$V_{in} = 0.2\text{ V}$	0.0		5.0	V
		$V_{in} = 0.5\text{ V}$	0.0		5.0	V
Quiescent current (in operating mode with a transformer connected)	I_q	$V_{in} = 0.05\text{ V}$, $V_{out} = 1.9\text{ V}$		2.2		mA
		$V_{in} = 0.15\text{ V}$, $V_{out} = 3.8\text{ V}$		3.1		mA
		$V_{in} = 0.3\text{ V}$, $V_{out} = 3.8\text{ V}$		2.8		mA
		$V_{in} = 0.5\text{ V}$, $V_{out} = 3.8\text{ V}$		2.5		mA

*oc: open circuit

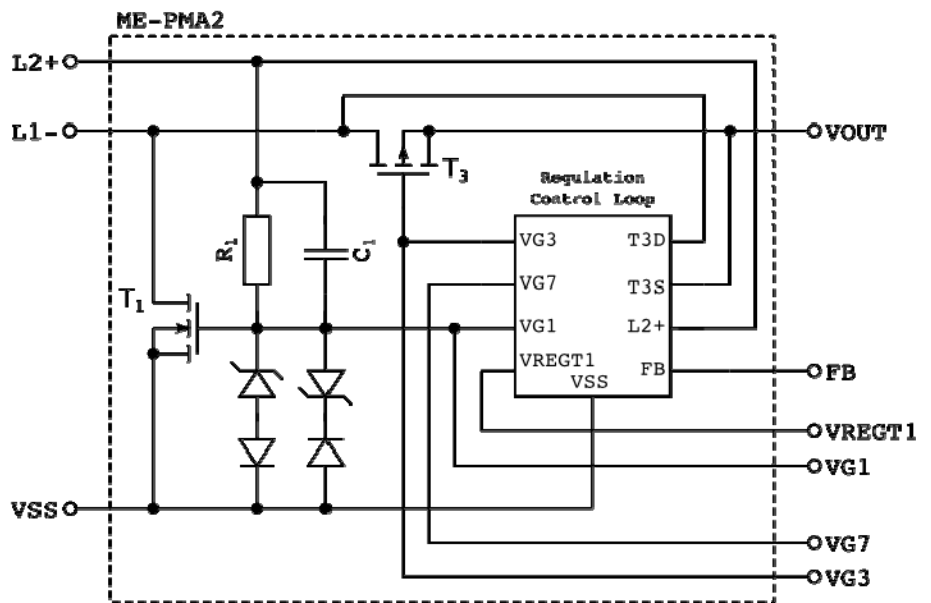

Fig. 3: Simplified block diagram of ME-PMA2

Detailed Description

A simplified block diagram of ME-PMA2 is illustrated in Fig. 3. It is a self-oscillating boost converter working in the boundary between continuous and discontinuous mode. This means that the current of the primary inductor of the connected transformer is always greater than zero. It is a flyback converter type, therefore the energy is at first stored in the primary inductor and in a second phase transferred to the output capacitor. The secondary winding is only needed for controlling the switching transistors.

The DC-DC converter minimizes energy losses using a synchronous design with a second switching transistor instead of a free-wheeling diode between output capacitor and inductor.

DC-DC converter application circuit

A typical DC-DC converter circuit using the ME-PMA2 is shown in Fig. 4. It is suitable for output voltages from 1.5 to about 5 V. The output voltage can be adjusted with a potentiometer connected at the FB Pin between the VOUT and VSS Pin of the IC. To achieve a better accuracy an additional zener diode can be connected between VOUT and the potentiometer like in Fig. 4.

The recommended transformer consists of a ER9.5/N87 core. To provide startup voltages below 20 mV the secondary to primary winding ratio needs to be at least 3:1. The ohmic resistance on the primary side should be below 0.5 Ohms in order to maintain highest possible efficiency.

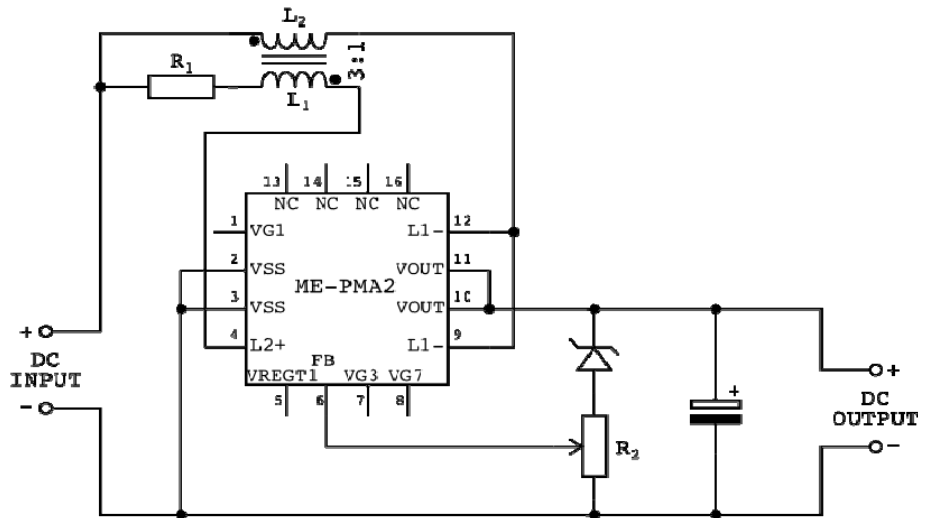

Fig. 4: Micro power ASIC in a DC-DC converter application

Pin Description

Pin	Name	Function
1	VG1	Test-Pin Control Voltage Transistor T1
2	VSS	Negative Pin Input Voltage
3	VSS	Negative Pin Input Voltage
4	L2+	Positive Pin Secondary Side
5	VREGT1	Test-Pin Regulation Voltage Transistor T1
6	FB	Input Regulation Loop
7	VG3	Test-Pin Control Voltage Transistor T3
8	VG7	Test-Pin
9	L1-	Negative Pin Primary Side
10	VOUT	Positive Pin Output Voltage
11	VOUT	Positive Pin Output Voltage
12	L1-	Negative Pin Primary Side
13	N.C.	(not connected)
14	N.C.	(not connected)
15	N.C.	(not connected)
16	N.C.	(not connected)

Typical Operating Characteristics

The measurements shown on the following pages have been done with two types of transformers consisting of the coupled inductors L₁ and L₂ (see Fig. 4). Type 1 (Measurements in Fig. 5,6 and 7) is optimized for a high efficiency, whereas type 2 (Measurements in Fig. 8,9 and 10) is optimized for a high output current. For both the mentioned ER9.5/N87 core was used. Smaller transformer cores may be used also, but will result in a lower converter efficiency.

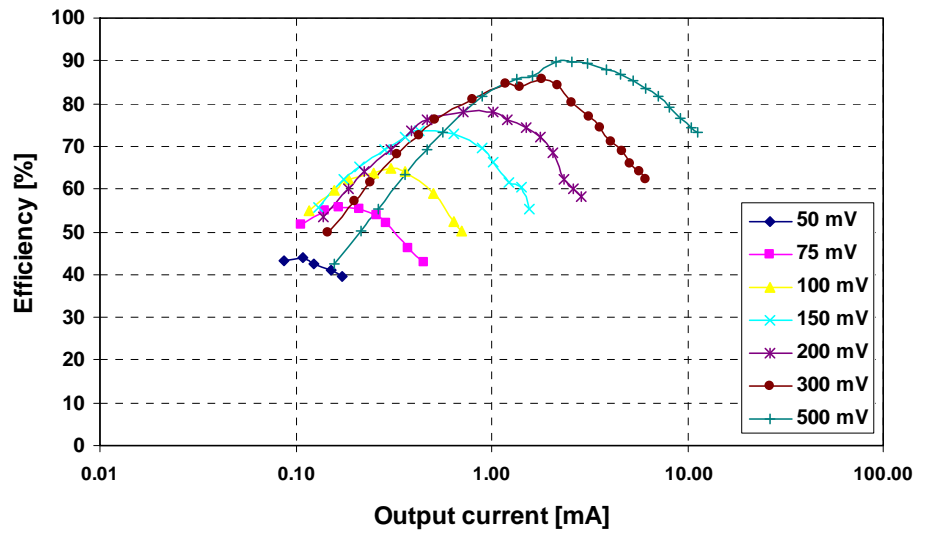

Fig. 5: Efficiency versus output current at different input voltages (transformer type 1)

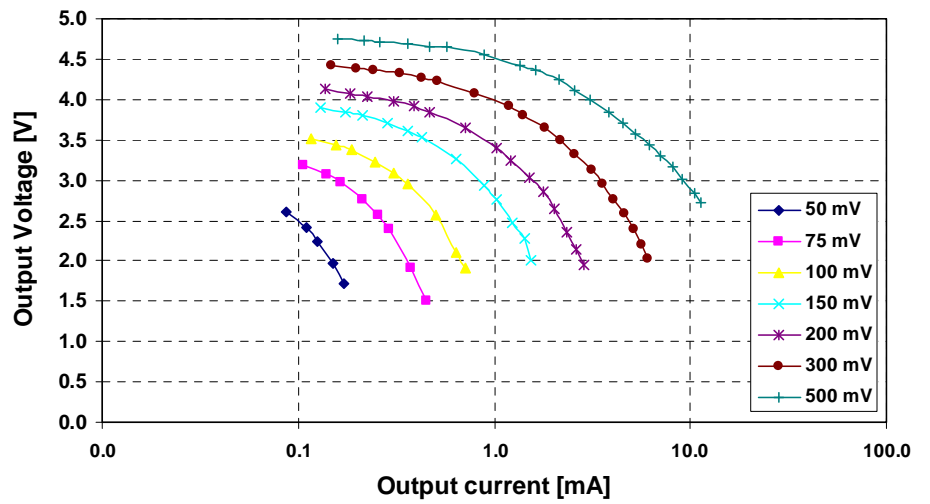

Fig. 6: Output voltage versus output current at different input voltages (transformer type 1)

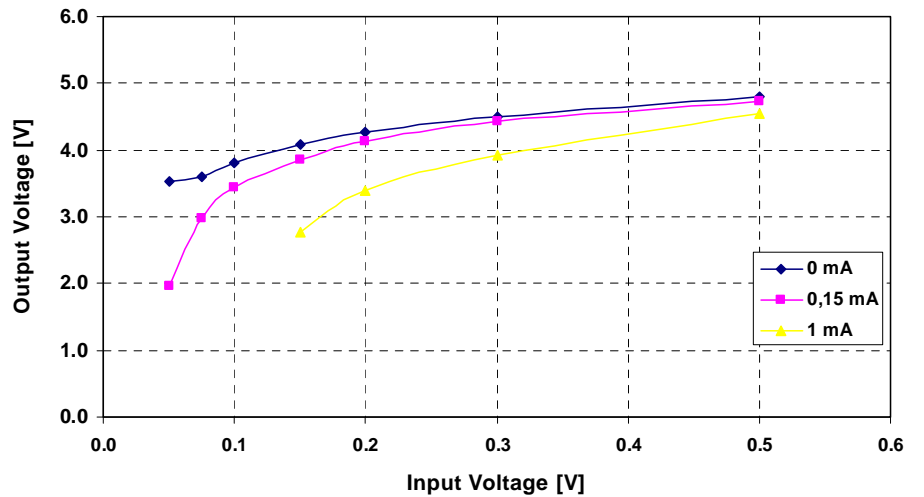

Fig. 7: Output voltage versus input voltage at different output currents (transformer type 1)

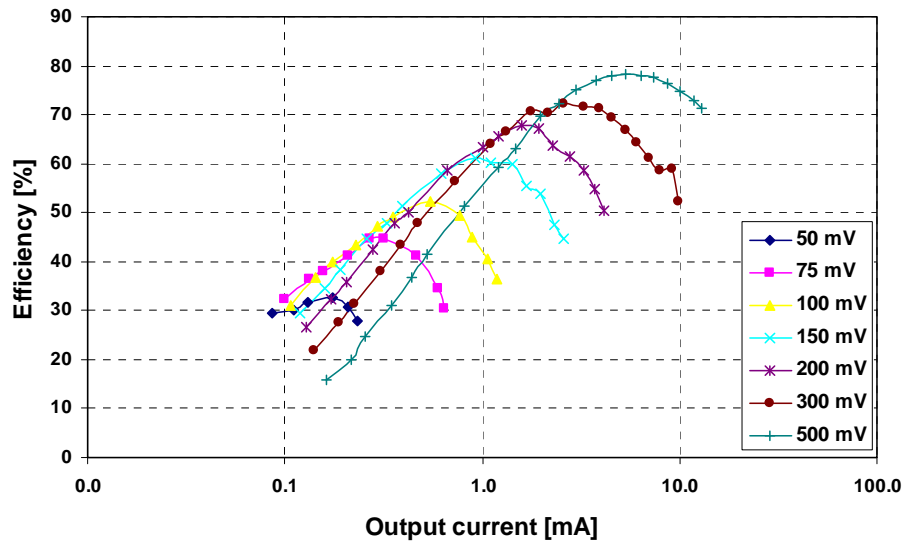

Fig. 8: Efficiency versus output current at different input voltages (transformer type 2)

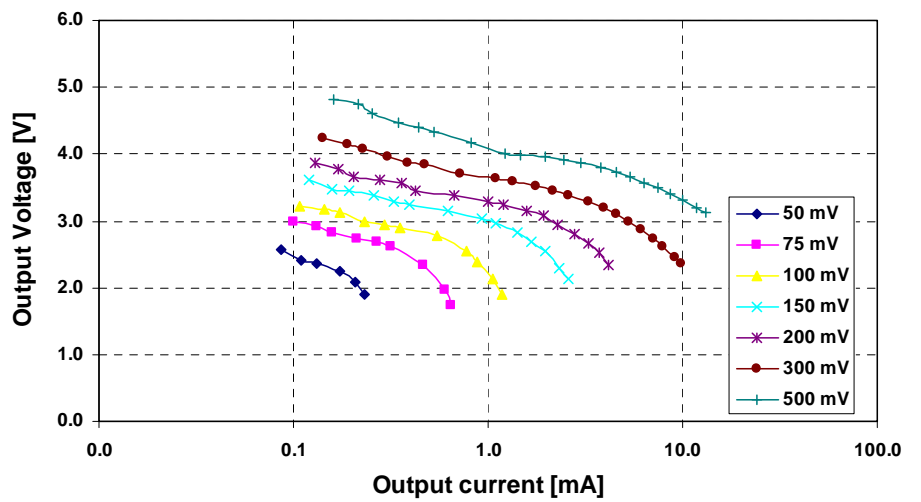

Fig.9: Output voltage versus output current at different input voltages (transformer type 2)

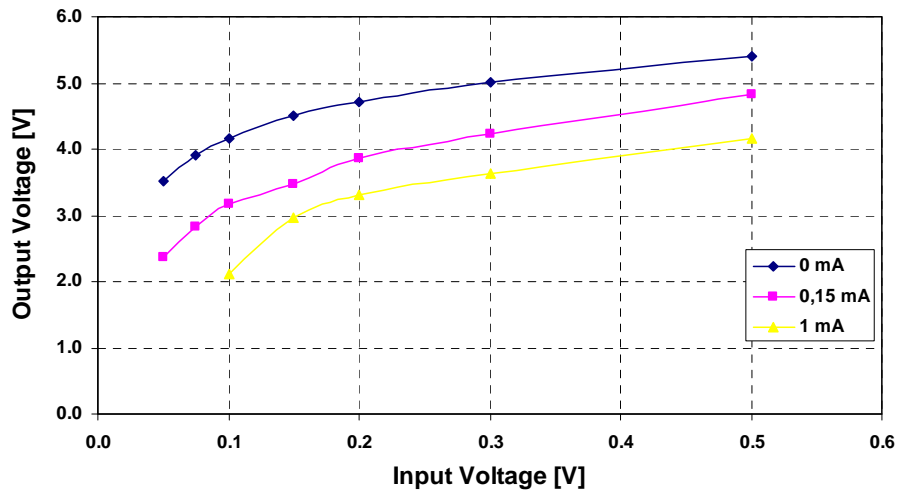
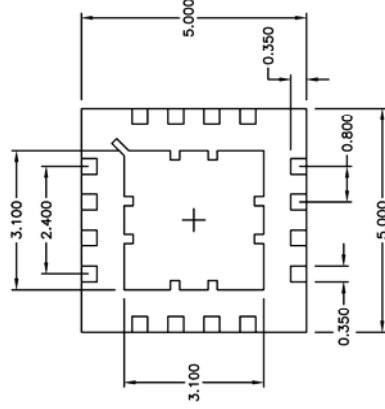
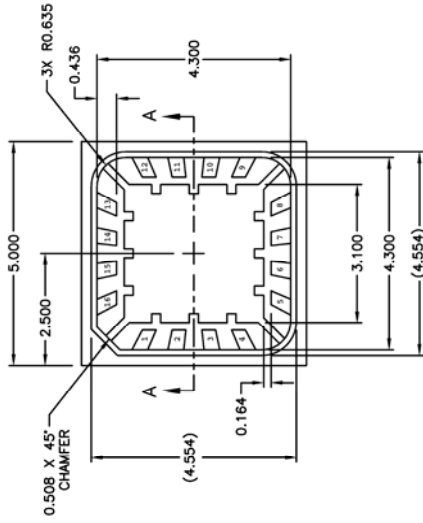
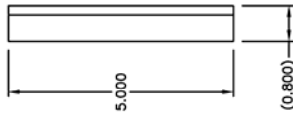

Fig. 10: Output voltage versus input voltage at different output currents (transformer type 2)

REVISIONS		DESCRIPTION	APPROVED
CDR NO.	DATE	PRODUCTION RELEASE	D.BENAVIDO
10490	10/27/05		



BOTTOM VIEW



TOP VIEW

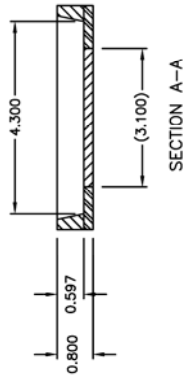

SECTION A-A

- NOTES:
1. BODY: PLASTIC, SEMICONDUCTOR GRADE.
 2. LEAD FRAME: COPPER, PH 194.
 3. LEAD FINISH: FULL GOLD PLATE.
 4. FRAME THICKNESS: 0.2030 ± 0.0076.
 5. DIE PAD: 3.100 X 3.100.
 6. JEDEC OUTLINE: MO-220 (VHHB).

SEMPAC, INC.
 Open-Pak™ Technologies
 www.sempac.com
 598 E. WEDDELL DRIVE, SUITE 5
 CHANDLER, AZ 85226
 PHONE: (480) 400-2602 FAX: (480) 400-2008

16 Lead 5.00mm x 5.00mm
 MLP Open-Pak

THIS SIZE PRODUCTION	DATE	07/05/05
UNLESS OTHERWISE SPECIFIED TOLERANCES ARE IN MILLIMETERS	DATE	07/05/05
3.XXX ± 0.15	BY	P. FLASKERUD
2.XXX ± 0.050	CHECKED	---
ANGLES: ± 1°	APPROVED	---
DO NOT SCALE DRAWING	THIS DOCUMENT CONTAINS INFORMATION PROPRIETARY TO SEMIPAC, INC. AND REPRODUCTION OR DISSEMINATION WITHOUT WRITTEN AUTHORITY FROM SEMIPAC, INC.	

SIZE	PART NO.	REV
A	MLP5X5-16-OP-01	1
SCALE	NONE	
	MLP5X5-16-OP-01-RI.DWG	SHEET 1 OF 1